

# MOUNTING AND OPERATING INSTRUCTIONS

**SAMSON**

## **EB 5863 EN**

### **Translation of original instructions**



Type 3226/5857  
Type 3226/5757-7



Type 3226/2780-2 ·  
Version with Type 3760  
Positioner



Type 3226/5827

**Electric Control Valves · Types 3226/5857, 3226/5827,  
3226/5757-7, 3226/5724-8, 3226/5725-8**

**Pneumatic Control Valves · Type 3226/2780**

## Note on these mounting and operating instructions

These mounting and operating instructions assist you in mounting and operating the device safely. The instructions are binding for handling SAMSON devices. The images shown in these instructions are for illustration purposes only. The actual product may vary.

- For the safe and proper use of these instructions, read them carefully and keep them for later reference.
- If you have any questions about these instructions, contact SAMSON's After-sales Service (aftersalesservice@samsongroup.com).



Documents relating to the device, such as the mounting and operating instructions, are available on our website at [www.samsongroup.com](http://www.samsongroup.com) > **Downloads** > **Documentation**.

## Definition of signal words

### **DANGER**

*Hazardous situations which, if not avoided, will result in death or serious injury*

### **WARNING**

*Hazardous situations which, if not avoided, could result in death or serious injury*

### **NOTICE**

*Property damage message or malfunction*

### **Note**

*Additional information*

### **Tip**

*Recommended action*

<b>1</b>	<b>Safety instructions and measures .....</b>	<b>1-1</b>
1.1	Notes on possible severe personal injury.....	1-5
1.2	Notes on possible personal injury .....	1-5
1.3	Notes on possible property damage .....	1-8
<b>2</b>	<b>Markings on the device .....</b>	<b>2-1</b>
2.1	Valve nameplate.....	2-1
2.2	Actuator nameplate.....	2-1
<b>3</b>	<b>Design and principle of operation.....</b>	<b>3-1</b>
3.1	Fail-safe action.....	3-1
3.2	Versions.....	3-3
3.3	Additional fittings.....	3-5
3.4	Technical data.....	3-5
<b>4</b>	<b>Shipment and on-site transport .....</b>	<b>4-1</b>
4.1	Accepting the delivered goods .....	4-1
4.2	Removing the packaging from the valve .....	4-1
4.3	Transporting and lifting the valve .....	4-1
4.4	Storing the valve.....	4-1
<b>5</b>	<b>Installation.....</b>	<b>5-1</b>
5.1	Installation conditions .....	5-1
5.2	Preparation for installation.....	5-2
5.3	Mounting the device .....	5-3
5.3.1	Installing the control valve into the pipeline .....	5-3
5.3.2	Mounting actuators .....	5-4
5.3.3	Connecting the actuator.....	5-4
5.3.4	Configuring the actuator .....	5-4
5.4	Testing the installed valve.....	5-4
5.4.1	Leak test .....	5-6
5.4.2	Travel motion.....	5-6
5.4.3	Fail-safe position .....	5-7
5.4.4	Pressure test.....	5-7
<b>6</b>	<b>Start-up.....</b>	<b>6-1</b>
<b>7</b>	<b>Operation .....</b>	<b>7-1</b>
<b>8</b>	<b>Malfunctions.....</b>	<b>8-1</b>
8.1	Troubleshooting.....	8-1
8.2	Emergency action.....	8-2

## Contents

<b>9</b>	<b>Servicing</b> .....	<b>9-1</b>
<b>10</b>	<b>Decommissioning</b> .....	<b>10-1</b>
<b>11</b>	<b>Removal</b> .....	<b>11-1</b>
11.1	Removing the valve from the pipeline.....	11-2
11.2	Removing the actuator .....	11-2
<b>12</b>	<b>Repairs</b> .....	<b>12-1</b>
12.1	Returning devices to SAMSON .....	12-1
<b>13</b>	<b>Disposal</b> .....	<b>13-1</b>
<b>14</b>	<b>Certificates</b> .....	<b>14-1</b>
<b>15</b>	<b>Appendix</b> .....	<b>15-1</b>
15.1	After-sales service .....	15-1

# 1 Safety instructions and measures

## Intended use

The SAMSON Type 3226 Valve is designed for use in temperature control circuits in HVAC plants. The valve is primarily combined with the following SAMSON actuators:

- As an electric control valve: Type 3226/5857, Type 3226/5827, Type 3226/5757-7, Type 3226/5724-8 and Type 3226/5725-8
- As a pneumatic control valve: Type 3226/2780

The valve with its actuator is designed to operate under exactly defined conditions (e.g. operating pressure, process medium, temperature). Therefore, operators must ensure that the control valve is only used in operating conditions that meet the specifications used for sizing the valve at the ordering stage. In case operators intend to use the control valve in applications or conditions other than those specified, contact SAMSON.

SAMSON does not assume any liability for damage resulting from the failure to use the device for its intended purpose or for damage caused by external forces or any other external factors.

➔ Refer to the technical data and nameplate for limits and fields of application as well as possible uses.

## Reasonably foreseeable misuse

The control valve is not suitable for the following applications:

- Use outside the limits defined during sizing and by the technical data
- For pneumatic control valves: use outside the limits defined by the valve accessories mounted on the control valve

Furthermore, the following activities do not comply with the intended use:

- Use of non-original spare parts
- Performing service and repair work not described

## Qualifications of operating personnel

The control valve must be mounted, started up, serviced and repaired by fully trained and qualified personnel only; the accepted industry codes and practices must be observed. According to these mounting and operating instructions, trained personnel refers to individuals who are able to judge the work they are assigned to and recognize possible hazards due to their specialized training, their knowledge and experience as well as their knowledge of the applicable standards.

## **Safety instructions and measures**

Welding operations are to be performed only by personnel who has the necessary qualification to perform the applied welding procedure and handle the materials used.

### **Personal protective equipment**

SAMSON recommends wearing the following protective equipment:

- Protective clothing, safety gloves and eye protection in applications with hot or cold media

➔ Check with the plant operator for details on further protective equipment.

### **Revisions and other modifications**

Revisions, conversions or other modifications of the product are not authorized by SAMSON. They are performed at the user's own risk and may lead to safety hazards, for example. Furthermore, the product may no longer meet the requirements for its intended use.

### **Safety features**

In combination with the Type 5827-A and Type 5827-E Electric Actuators as well as with the TROVIS 5725-8 Electric Actuator with Process Controller, the following safety feature exists: upon failure of the supply voltage, the valve moves to a defined fail-safe position (see the 'Design and principle of operation' chapter). The direction of action of the fail-safe action is defined by the actuator version (see associated actuator documentation).

In combination with the Type 2780 Pneumatic Actuator, the following safety feature exists: upon failure of the air supply, the valve moves to a certain fail-safe position (see the 'Design and principle of operation' chapter). The fail-safe action of the actuator is the same as its direction of action and is specified on the nameplate of SAMSON actuators (see associated actuator documentation).

### **Warning against residual hazards**

To avoid personal injury or property damage, plant operators and operating personnel must prevent hazards that could be caused in the control valve by the process medium, the operating pressure, the signal pressure or by moving parts by taking appropriate precautions. Plant operators and operating personnel must observe all hazard statements, warnings and caution notes in these mounting and operating instructions.

Hazards resulting from the special working conditions at the installation site of the valve must be identified in a risk assessment and prevented through the corresponding standard operating procedures drawn up by the operator.

### **Responsibilities of the operator**

Operators are responsible for proper use and compliance with the safety regulations. Operators are obliged to provide these mounting and operating instructions as well as the referenced documents to the operating personnel and to instruct them in proper operation. Furthermore, operators must ensure that operating personnel or third parties are not exposed to any danger.

Operators are additionally responsible for ensuring that the limits for the product defined in the technical data are observed. This also applies to the start-up and shutdown procedures. Start-up and shutdown procedures fall within the scope of the operator's duties and, as such, are not part of these mounting and operating instructions. SAMSON is unable to make any statements about these procedures since the operative details (e.g. differential pressures and temperatures) vary in each individual case and are only known to the operator.

### **Responsibilities of operating personnel**

Operating personnel must read and understand these mounting and operating instructions as well as the referenced documents and observe the specified hazard statements, warnings and caution notes. Furthermore, operating personnel must be familiar with the applicable health, safety and accident prevention regulations and comply with them.

### **Referenced standards, directives and regulations**

The control valves comply with the requirements of the European Pressure Equipment Directive 2014/68/EU. Valves with a CE marking have a declaration of conformity, which includes information about the applied conformity assessment procedure. The 'Certificates' chapter contains this declaration of conformity.

The electric actuators are designed for use in low voltage installations. For wiring, maintenance and repair, observe the relevant safety regulations.

## Safety instructions and measures

### Referenced documents

The following documents apply in addition to these mounting and operating instructions:

- Mounting and operating instructions for mounted actuator, e.g. SAMSON actuators:
  - ▶ EB 5857 for Type 5857
  - ▶ EB 5827-1/-2 for Type 5827
  - ▶ EB 5757-7 for TROVIS 5757-7
  - ▶ EB 5724-8 for TROVIS 5724-8 and TROVIS 5725-8
  - ▶ EB 5840 for Type 2780
- For pneumatic control valves: mounting and operating instructions for mounted valve accessories (positioner, solenoid valve etc.)
- If a device contains a substance listed as a substance of very high concern (SVHC) on the candidate list of the REACH regulation, the document "Additional Information on Your Inquiry/Order" is added to the SAMSON order documents. This document includes the SCIP number assigned to the devices concerned. This number can be entered into the database on the European Chemicals Agency (ECHA) website (▶ <https://www.echa.europa.eu/scip-database>) to find out more information on the SVHC contained in the device.  
Further information on material compliance at SAMSON is available at  
▶ [www.samsongroup.com](http://www.samsongroup.com) > About SAMSON > Environment, Social & Governance > Material Compliance.



## 1.1 Notes on possible severe personal injury

### DANGER

#### **Risk of bursting in pressure equipment.**

Control valves and pipelines are pressure equipment. Excessive pressurization or improper opening can lead to valve components bursting.

- Observe the maximum permissible pressure for valve and plant.
- Before starting any work on pressure-bearing or pressure-retaining parts belonging to the valve assembly, depressurize all plant sections affected as well as the valve.
- Drain the process medium from the plant sections affected as well as from the valve.

#### **Risk of fatal injury due to electric shock.**

- While working on electric devices or before opening the device, disconnect the supply voltage and protect it against unintentional reconnection.
- Do not remove any covers to perform adjustment work on live parts.
- Only use protective equipment that can be protected against unintentional reconnection of the power supply.
- SAMSON electric actuators are protected against spray water. Avoid jets of water.
- Observe all other safety instructions in the associated documentation of the electric device (e.g. electric actuator).

## 1.2 Notes on possible personal injury

### WARNING

#### **Crush hazard arising from moving parts.**

The pneumatic control valve (Type 3226/2780) contains moving parts (actuator and plug stems), which can injure hands or fingers if inserted into the valve.

- Before working on the control valve, disconnect and lock the pneumatic air supply as well as the control signal.

### **WARNING**

#### **Risk of personal injury due to exhaust air being vented from pneumatically operated components.**

When the valve is operated with a pneumatic actuator or pneumatic valve accessories, exhaust air is vented from the actuator, for example, while the valve is operating and when the valve opens or closes.

- Install the control valve in such a way that vent openings are not located at eye level and the actuator does not vent at eye level in the work position.
- Use suitable mufflers and vent plugs.
- Wear eye protection when working in close proximity to the control valve.

#### **Risk of personal injury due to preloaded springs in pneumatic actuators.**

Valves in combination with pneumatic actuators with preloaded springs are under tension. These control valves with SAMSON pneumatic actuators can be identified by the long bolts protruding from the bottom of the actuator.

- Before starting any work on the actuator, relieve the compression from the preloaded springs (see associated actuator documentation).

#### **Risk of personal injury due to residual process medium in the valve.**

While working on the valve, residual process medium can escape and, depending on its properties, may lead to personal injury, e.g. burns.

- Follow the standard operating procedures provided by the plant operator. In the event of a potential risk:
  - If possible, drain the process medium from the plant sections affected and from the valve.
  - Wear protective clothing, safety gloves, respiratory protection and eye protection.

#### **Risk of burn injuries due to hot components and pipelines.**

Depending on the process medium, valve components and pipelines may get very hot and cause burn injuries.

- Follow the standard operating procedures provided by the plant operator. In the event of a potential risk:
  - Allow components and pipelines to cool down.
  - Wear protective clothing and safety gloves.

### **WARNING**

#### **Risk of hearing loss or deafness due to loud noise.**

The noise emissions depend on the valve version, plant facilities and process medium.

- Follow the standard operating procedures provided by the plant operator. In the event of a potential risk:
  - Wear hearing protection when working near the valve.

#### **Exposure to hazardous substances poses a serious risk to health.**

Certain lubricants and cleaning agents are classified as hazardous substances. These substances have a special label and a material safety data sheet (MSDS) issued by the manufacturer.

- Make sure that an MSDS is available for any hazardous substance used. If necessary, contact the manufacturer to obtain an MSDS.
- Inform yourself about the hazardous substances and their correct handling.

#### **Risk of personal injury due to incorrect operation, use or installation as a result of information on the control valve being illegible.**

Over time, markings, labels and nameplates on the control valve may become covered with dirt or become illegible in some other way. As a result, hazards may go unnoticed and the necessary instructions not followed. There is a risk of personal injury.

- Keep all relevant markings and inscriptions on the device in a constantly legible state.
- Immediately renew damaged, missing or incorrect nameplates or labels.

## 1.3 Notes on possible property damage

### NOTICE

#### **Risk of damage to the electric control valve due to the supply voltage exceeding the permissible tolerances.**

The electric control valves are designed for use according to regulations for low-voltage installations.

→ Observe the permissible tolerances of the supply voltage. See associated actuator documentation.

#### **Risk of valve damage due to contamination (e.g. solid particles) in the pipeline.**

The plant operator is responsible for cleaning the pipelines in the plant.

→ Flush the pipelines before start-up.

#### **Risk of valve damage due to unsuitable medium properties.**

The valve is designed for water and non-flammable gases as the process medium.

→ Do not use any other process media.





## 2 Markings on the device

The nameplate shown was up to date at the time of publication of this document. The nameplate on the device may differ from the one shown.

### 2.1 Valve nameplate

It includes all details required to identify the device:

Item	Inscription meaning
1	Model number
2	Type designation
3	Flow coefficient
4	Pressure rating
5	Material number
6	Serial number
7	DVGW test number
8	Country of origin
10	CE marking: ID of the notified body (EU)
11	Other marks of conformity
12	Month and year of manufacture
13	Perm. temperature
14	Permissible differential pressure $\Delta p$ (Type 2433 only)

Item	Inscription meaning
15	Type of valve/direction of flow symbol (DN 15 to 50)
	 Mixing valve in upright mounting position
	 Diverting valve in upright mounting position
	 Mixing valve in suspended mounting position
	 Diverting valve in suspended mounting position

#### Tip

*SAMSON recommends to include the device's serial number (item 6 on the nameplate) and/or the material number (as specified in the order confirmation) in the plant documentation for the associated tag number.*

*For example, you can use the associated information to order a new nameplate from our after-sales service, if required.*

### 2.2 Actuator nameplate

See associated actuator documentation.

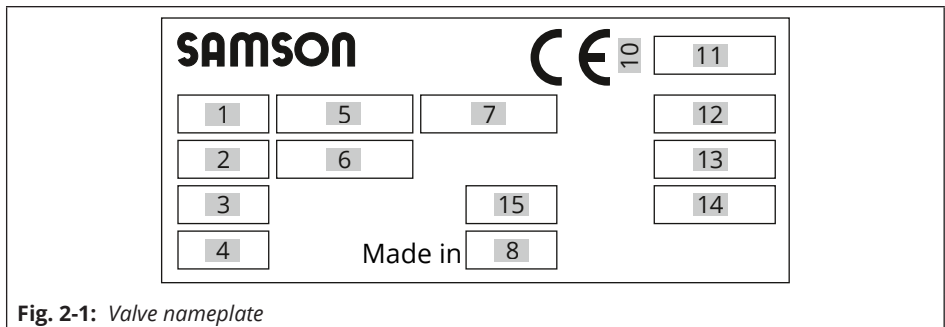

Fig. 2-1: Valve nameplate



### 3 Design and principle of operation

The three-way valve in the version with male thread connection and welding ends or threaded ends can be used for both mixing or diverting valves. The version with female thread connection can only be used for mixing valves.

In mixing valves, the process media to be mixed enter at valve ports A and B.

The combined flow exits the valve at port AB.

In diverting valves, the process medium enters at the valve port AB and the partial flows exit at ports A and B.

The process medium flows through the three-way valve in the direction indicated by the arrow. The position of the plug (3) determines the cross-sectional area of flow between the plug and the seat (2).

The plug follows the actuator stem (8.2), which is changed by the control signal acting on the actuator (8), owing to the force of the valve spring (5).

The valve and actuator have a force-locking connection.

#### 3.1 Fail-safe action

When the Type 3226 Valve is combined with one of the following actuators, the valve moves to the fail-safe position upon failure of the air supply or supply voltage:

- Type 5827-A and Type 5827-E Electric Actuators

- TROVIS 5725-8 Electric Actuator with Process Controller

- Type 2780 Pneumatic Actuator

One of two different fail-safe positions can be assumed by the control valve:

- **Actuator stem extends:** upon supply voltage or air supply failure, the actuator stem extends. In mixing valves, port B is closed and in diverting valves, port A is closed.
- **Actuator stem retracts:** upon supply voltage or air supply failure, the actuator stem retracts. In mixing valves, port A is closed and in diverting valves, port B is closed.

---

#### **i** Note

*The fail-safe action of pneumatic actuators can be reversed (see associated actuator documentation). The fail-safe action of electric actuators (with process controller) is already determined at the ordering stage.*

---

# Design and principle of operation

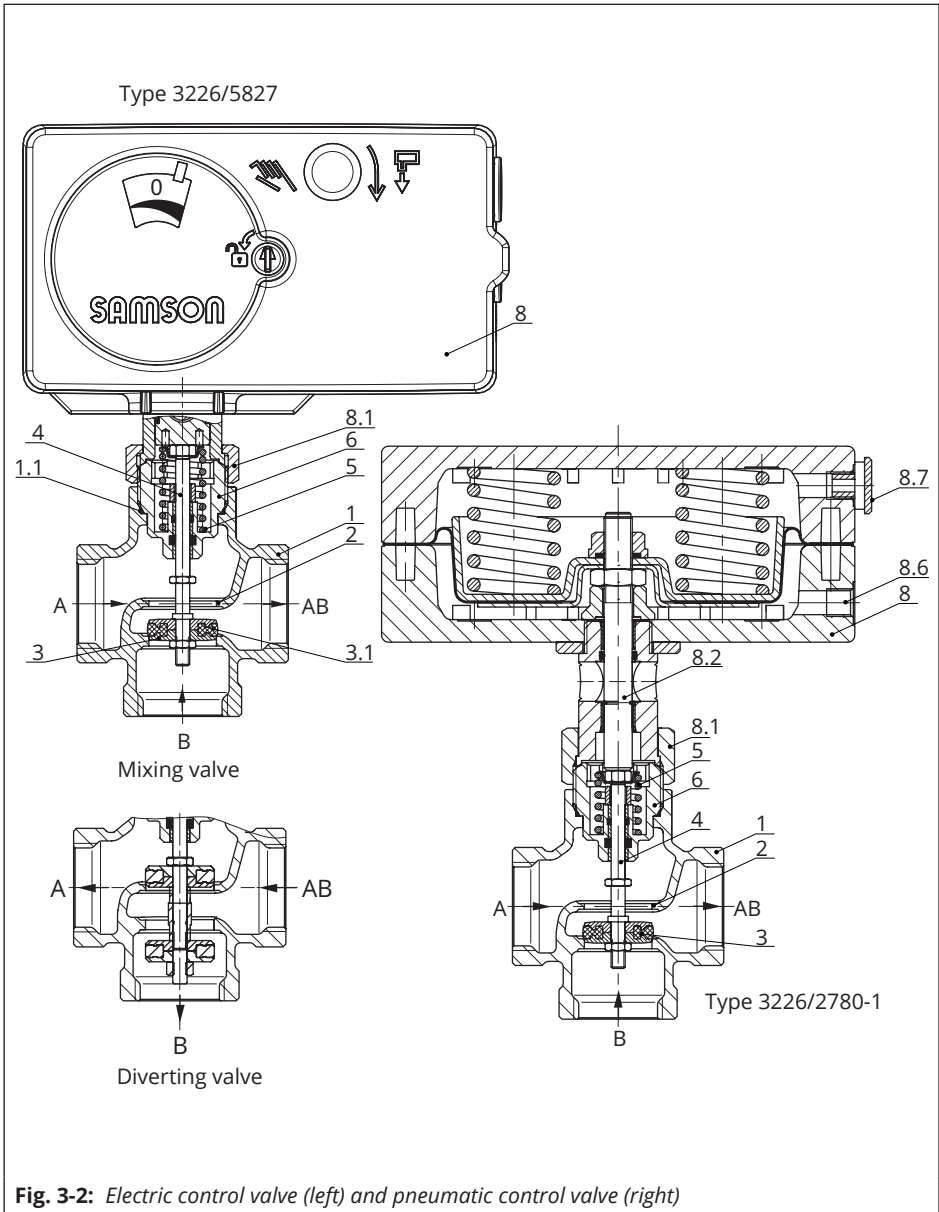

**Fig. 3-2:** Electric control valve (left) and pneumatic control valve (right)



### 3.2 Versions

#### Intermediate insulating piece

An intermediate insulating piece (1990-1712) is available for insulated pipes.

#### DVGW test

The Type 3226 Three-way Valve is available as a mixing or diverting valve in the special version with DVGW test (for PN 10, 5 to 90 °C).

#### Electric actuators

The Types 5857 and 5827 Electric Actuators can either be controlled using a three-step signal or, in the version with positioner, with continuous signals which can be adjusted in ranges from 0 to 20 mA or 0 to 10 V. Various electrical accessories can be optionally installed. Type 5827-A and Type 5827-E Actuators are able to perform a fail-safe action (see Table 3-1).

#### Electric actuators with process controllers

Electric actuators with process controller are a combination of an electric actuator and a digital process controller. The TROVIS 5757-7, TROVIS 5724-8 and TROVIS 5725-8 Electric Actuators with Process Controller are suitable for heating and cooling applications. TROVIS 5724-8 and TROVIS 5725-8 have two PID control modules and are ready-wired. The TROVIS 5725-8 Actuator is able to perform a fail-safe action. Refer to Table 3-1.

#### Pneumatic actuators

The Type 2780-1 Pneumatic Actuator uses a control signal from 0.4 to 1 bar and Type 2780-2 uses a control signal from 0.4 to 2 bar which is applied to the signal pressure connection. The pneumatic actuators require a supply pressure of at least 0.2 bar above the maximum bench range. See Chapter 3.1 for details on the fail-safe position.

#### Legend for Fig. 3-2

1 Valve body	4 Plug stem	8.2 Actuator stem
1.1 Body gasket	5 Valve spring	8.6 Signal pressure connection
2 Seat	6 Adapter	8.7 Vent plug
3 Plug	8 Actuator	
3.1 Plug with soft sealing	8.1 Coupling nut	

## Design and principle of operation

**Table 3-1:** Available versions and possible combinations (Type 3226 Valve/actuator)

Type/ TROVIS	Fail-safe action: Actuator stem		Nominal size DN						Thread size G		
	Extends	Retracts	15	20	25	32	40	50	½	¾	1
<b>Electric actuators</b>											
5857 <sup>1)</sup>	–	–	•	•	•	–			•	•	•
5827-N1	–	–	•	•	•	–			•	•	•
5827-A1	•	–	•	•	•	–			•	•	•
5827-E1	–	•	•	•	•	–			•	•	•
5827-N2	–	–	–			•	•	•	–		
5827-A2	•	–	–			•	•	•	–		
5827-E2	–	•	–			•	•	•	–		
<b>Electric actuators with process controller for heating and cooling applications</b>											
5757-7 <sup>1)</sup>	–	–	•	•	•	–			•	•	•
5724-810	–	–	•	•	•	–			•	•	•
5724-820	–	–	–			•	•	•	–		
5725-810	•	–	•	•	•	–			•	•	•
5725-820	•	–	–			•	•	•	–		
<b>Pneumatic actuators</b>											
2780-1	•	•	•	•	•	•	•	•	•	•	•
2780-2	•	•	•	•	•	•	•	•	•	•	•

<sup>1)</sup> The valve spring in the Type 3226 Valve intended for mounting on the Types 5857 and TROVIS 5757-7 Actuators is different from that of the Type 3226 intended for mounting on other actuators. Basically, actuators with a larger nominal thrust (e.g. Type 5827) may also be combined with valves for Types 5857 and TROVIS 5757-7 Actuators, however, not vice versa.

### 3.3 Additional fittings

Refer to the instructions in the 'Installation' chapter.

#### Strainers

SAMSON recommends installing a SAMSON Type 2 NI Strainer upstream of the valve. It prevents solid particles in the process medium from damaging the control valve.

#### Bypass line and shut-off valves

SAMSON recommends installing a shut-off valve both upstream of the strainer and downstream of the control valve and installing a bypass line. The bypass line ensures that the plant does not need to be shut down for service and repair work on the valve.

#### Intermediate insulating piece

An intermediate insulating piece (1990-1712) must be used under the following conditions:

- For medium temperatures between  $-15$  to  $+5$  °C (actuators according to Table 3-1)
- In networks with a constant medium temperature  $>135$  °C (TROVIS 5724-8, TROVIS 5725-8 and Type 5827 Actuators)
- For liquids  $>120$  °C (TROVIS 5757-7 and Type 5857 Actuators)

### 3.4 Technical data

The nameplates on the valve and actuator provide information on the control valve version. See the 'Markings on the device' chapter and the associated actuator documentation.

---

#### **i** Note

*More information is available in Data Sheet ▶ T 5863.*

---

#### Noise emissions

SAMSON is unable to make general statements about noise emissions. The noise emissions depend on the valve version, plant facilities and process medium.

## Design and principle of operation

**Table 3-2: Technical data**

<b>Nominal size</b>	<b>Mixing or diverting valve with male thread connection</b>	<b>DN</b>	<b>15</b>	<b>20</b>	<b>25</b>	<b>32</b>	<b>40</b>	<b>50</b>
<b>Connection size</b>	<b>Mixing valve with female thread</b>	<b>G</b>	$\frac{1}{2}$	$\frac{3}{4}$	<b>1</b>	-	-	-
Pressure rating	PN	25						
DVGW version	PN	10						
Permissible temperature range	°C	+5 (-15) to 150 <sup>1)</sup>						
DVGW version	°C	+5 to 90						
Permissible differential pressure for actuators								
Type 5857, TROVIS 5757-7	bar	4	2.6	1.8	-	-	-	-
Type 5827, TROVIS 5724-8, TROVIS 5725-8, Type 2780	bar	4	4	4	1.7	1.1	1.1	1.1
Rated travel	mm	6	6	6	12	12	12	12
Seat-plug seal	Soft seal							
Leakage class according to IEC 60534-4	Class IV ( $\leq 0.01$ % of $K_{VS}$ coefficient)							
Conformity	<b>CE</b>							

<sup>1)</sup> Use an intermediate insulating piece (see Chapter 3.3, section "Intermediate insulating piece")

**Table 3-3: Materials**

<b>Valve body</b>	<b>CC499K (CuSn5Zn5Pb2-C)</b>
Plug	CW617N (CuZn40Pb2zh) with EPDM
Packing	O-rings made of EPDM
Welding ends	1.0460
Threaded ends	Red brass

**Table 3-4: Nominal sizes and  $K_{VS}$  coefficients**

<b>Nominal size</b>	<b>Mixing or diverting valve with male thread connection</b>	<b>DN</b>	<b>15</b>				<b>20</b>	<b>25</b>	<b>32</b>	<b>40</b>	<b>50</b>
<b>Connection size</b>	<b>Mixing valve with female thread</b>	<b>G</b>	$\frac{1}{2}$				$\frac{3}{4}$	<b>1</b>	-	-	-
$K_{VS}$ coefficient		mm	1.0	1.6	2.5	4	6.3	10	16	25	40
Rated travel		mm	6	6	6	6	6	6	12	12	12

**Dimensions and weights**

The lengths and heights in the dimensional drawings are shown on page 3-9.

**Table 3-5:** *Type 3226 Three-way Valve*

<b>Valves with male thread connection</b>							
<b>Nominal size</b>	<b>DN</b>	<b>15</b>	<b>20</b>	<b>25</b>	<b>32</b>	<b>40</b>	<b>50</b>
L	mm	65	70	75	100	110	130
H2	mm	41.5			52		
H3	mm	40	40	40	60	65	65
<b>... with welding ends</b>							
Thread size R	G	¾	1	1¼	1¾	2	2½
Pipe Ød	mm	21.3	26.8	33.7	42	48	60
Width across flats (A/F)		30	37	46	60	65	82
L2	mm	210	234	244	268	294	330
H4	mm	112	122	124	144	157	165
Weight without actuator	kg (approx.)	3.2	3.6	4.0	6.1	7.0	8.0
<b>... with threaded ends</b>							
Male thread A	G	½	¾	1	1¼	1½	2
Width across flats (A/F)		30	37	46	60	65	82
L3	mm	129	144	159	192	206	228
H5	mm	72	77	82	106	113	114
Weight without actuator	kg (approx.)	3.2	3.6	4.0	6.1	7.0	8.0
<b>Valves with female thread</b>							
<b>Thread size R1</b>	<b>G</b>	<b>½</b>	<b>¾</b>	<b>1</b>	<b>-</b>		
L1	mm	65	75	90	-		
H1	mm	40	40	40	-		
H2	mm	41.5			-		
Width across flats A/F 1		27	34	46	-		
Weight without actuator	kg (approx.)	0.9	1.1	1.3	-		

## Design and principle of operation

**Table 3-6:** *Electric actuators*

Type		5857	5827-N	5827-A/-E
Weight	kg (approx.)	0.7	0.75	1.0

**Table 3-7:** *Electric actuators with process controllers*

TROVIS		5757-7	5724-8	5725-8
Weight	kg (approx.)	0.7	1.1	1.3

**Table 3-8:** *Pneumatic actuators*

Type		2780-1	2780-2
Weight	kg (approx.)	2	3.2

**Electric control valves**

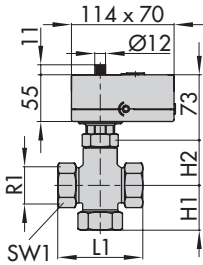

Type 3226/5857 and  
Type 3226/5757-7  
Only up to DN 25  
Version with female thread

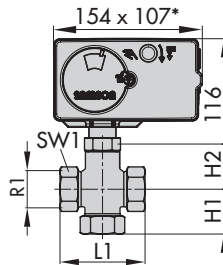

Types 3226/5827-xx  
\* Dimensions for actuators  
with double stroking speed:  
154x140 mm

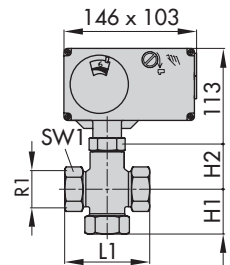

Types 3226/5724-8xx  
Types 3226/5725-8xx

**Pneumatic control valves**

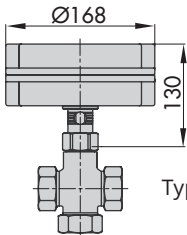

Type 3226/2780-1

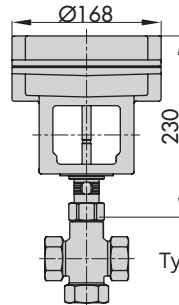

Type 3226/2780-2

**Versions**

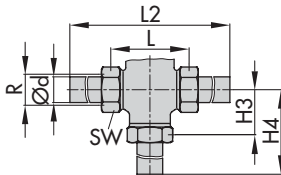

Version with male thread connection and  
welding ends

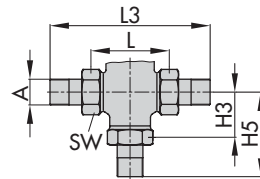

Version with threaded ends





## 4 Shipment and on-site transport

The work described in this chapter is to be performed only by personnel appropriately qualified to carry out such tasks.

### 4.1 Accepting the delivered goods

After receiving the shipment, proceed as follows:

1. Check the scope of delivery. Check that the specifications on the valve nameplate match the specifications in the delivery note. See the 'Markings on the device' chapter for nameplate details.
2. Check the shipment for transportation damage. Report any damage to SAMSON and the forwarding agent (refer to delivery note).

### 4.2 Removing the packaging from the valve

Observe the following sequence:

- Do not remove the packaging until immediately before installation in the pipeline.
- Dispose and recycle the packaging in accordance with the local regulations.

### 4.3 Transporting and lifting the valve

Due to the low service weight, lifting equipment is not required to lift and transport the control valve (e.g. to install it into the pipeline).

---

 **Tip**

*Our after-sales service can provide more detailed transport and lifting instructions on request.*

---

#### Transport instructions

- Protect the control valve against external influences (e.g. impact).
- Do not damage the corrosion protection (paint, surface coatings). Repair any damage immediately.
- Protect the control valve against moisture and dirt.
- Observe the permissible ambient temperature (see section 'Technical data' in the 'Design and principle of operation' chapter).

### 4.4 Storing the valve

---

 **NOTICE**

***Risk of valve damage due to improper storage.***

- *Observe the storage instructions.*
  - *Avoid longer storage periods.*
  - *Contact SAMSON in case of different storage conditions or longer storage times.*
-

## Shipment and on-site transport

---

### **i Note**

*SAMSON recommends to regularly check the control valve and the prevailing storage conditions during long storage periods.*

---

### **Storage instructions**

- The control valves can be stored horizontally. Secure the control valve assembly in the stored position against slipping or tipping over.
- Protect the control valve against external influences (e.g. impact).
- Do not damage the corrosion protection (paint, surface coatings). Repair any damage immediately.
- Protect the control valve against moisture and dirt. Store it at a relative humidity of less than 75 %. In damp spaces, prevent condensation. If necessary, use a drying agent or heating.
- Make sure that the ambient air is free of acids or other corrosive media.
- Observe the permissible ambient temperature (see section 'Technical data' in the 'Design and principle of operation' chapter).
- Do not place any objects on the control valve.

### **Special storage instructions for elastomers**

Elastomer, e.g. actuator diaphragm (in pneumatic actuators)

- To keep elastomers in shape and to prevent cracking, do not bend them or hang them up.
- SAMSON recommends a storage temperature of 15 °C for elastomers.
- Store elastomers away from lubricants, chemicals, solutions and fuels.

---

### **💡 Tip**

*Our after-sales service can provide more detailed storage instructions on request.*

---

## 5 Installation

The work described in this chapter is to be performed only by personnel appropriately qualified to carry out such tasks.

### 5.1 Installation conditions

#### Work position

The work position for the control valve is the front view looking onto the operating controls (including valve accessories).

Plant operators must ensure that, after installation of the device, the operating personnel can perform all necessary work safely and easily access the device from the work position.

#### Mounting position

Generally, SAMSON recommends installing the valve with the actuator upright and on top of the valve.

For versions with electric actuators (with process controller), the actuator must not be suspended downwards (see Fig. 5-1).

➔ Contact SAMSON if the mounting position is not as specified above.

#### Pipeline routing

The valves are supplied as either mixing or diverting valves. They can be used for both mixing as well as diverting service (see Fig. 5-2).

To ensure the control valve functions properly, follow the installation instructions given below:

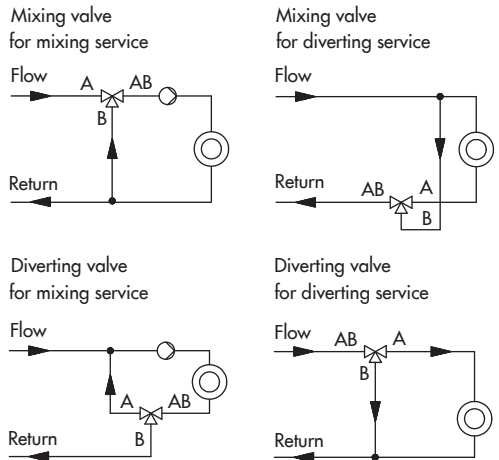
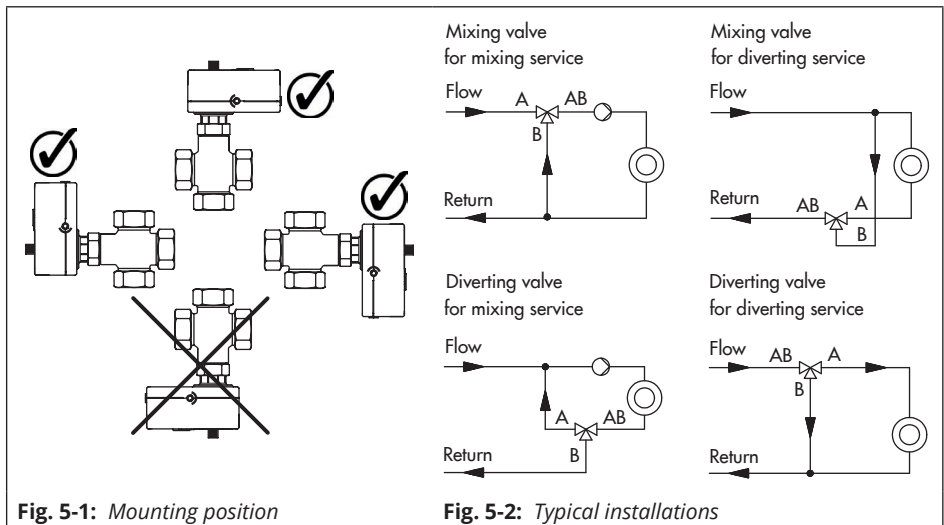

## Installation

- Make sure that the plant-related arrangement of inlet and outlet located at the ports **A**, **B** and **AB** comply with the symbols on the body nameplate. Fig. 5-2 shows examples of installation in the pipeline.
- Do not exceed the maximum permissible flow velocity.

---

### **i** Note

*The plant operator is responsible for determining the maximum permissible flow velocity. Our after-sales service can support you to determine the flow velocity for your plant.*

---

- Install the valve free of stress and with the least amount of vibrations as possible. Read sections "Mounting position" and "Valve accessories" in this chapter.
- Install the control valve allowing sufficient space to remove the actuator and valve or to perform service and repair work on them.

### Valve accessories

- During connection of valve accessories, make sure that they are easily accessible and can be operated safely from the work position.

### Vent plugs

Vent plugs are screwed into the exhaust air ports of pneumatic and electropneumatic devices. They ensure that any exhaust air that forms can be vented to

the atmosphere (to avoid excess pressure in the device). Furthermore, the vent plugs allow air intake to prevent a vacuum from forming in the device.

- Locate the vent plug on the opposite side to the work position of operating personnel.

## 5.2 Preparation for installation

Before installation, make sure that the following conditions are met:

- The valve is clean.
- The valve and all valve accessories (including piping) are not damaged.
- The valve data on the nameplate (type designation, nominal size, material, pressure rating and temperature range) match the plant conditions (nominal size and pressure rating of the pipeline, medium temperature etc.). See the 'Markings on the device' chapter for nameplate details.
- The requested or required additional pipe fittings (see the 'Additional fittings' chapter) have been installed or prepared as necessary before installing the valve.

Proceed as follows:

- Lay out the necessary material and tools to have them ready during installation work.
- Flush the pipelines.

**i Note**

*The plant operator is responsible for cleaning the pipelines in the plant.*

- ➔ Check any mounted pressure gauges to make sure they function properly.
- ➔ When the valve and actuator are already assembled, check the bolted joints. Components may loosen during transport.

### 5.3 Mounting the device

The activities listed below are necessary to install the valve and before it can be started up.

SAMSON recommends first installing the valve into the pipeline and mounting the actuator afterwards.

**! NOTICE**

***Risk of control valve damage due to over- or under-torquing.***

- ➔ *Observe the specified torques when tightening control valve components. Excessive tightening torques lead to parts wearing out more quickly. Parts that are too loose may cause leakage.*

### 5.3.1 Installing the control valve into the pipeline

**! NOTICE**

***Risk of valve damage due to work being carried out by personnel not qualified for such tasks.***

*The plant operator or specialist company performing the welding is responsible for the selection of the welding procedure and the actual welding operations on the valve. This also applies to any required heat treatment to be performed on the valve.*

- ➔ *Only allow qualified welding personnel to carry out welding operations.*

1. Close the shut-off valves in the pipeline at the inlet and outlet of the plant section while the valve is being installed.
2. Prepare the relevant section of the pipeline for installing the valve.

**Strainer:**

- ➔ Make sure the direction of flow of the strainer and valve are identical.
  - ➔ Install the strainer with the filter element facing downwards.
  - ➔ Allow sufficient space to remove the filter.
3. Remove the protective caps from the valve ports before installing the valve.

## Installation

- Lift the valve to the site of installation. Observe the flow direction through the valve. The arrow on the valve indicates the direction of flow.
- Valve version with flanges:** make sure that the correct flange gaskets are used.
- Connect the valve free of stress into the pipeline (depending on the version).

### Intermediate insulating piece

- Do not insulate the actuator and the coupling nut as well.
- Only insulate the intermediate insulating piece up to 25 mm at the maximum.

## 5.3.2 Mounting actuators

Mount the actuators as described in the associated actuator documentation:

- Type 5857 Electric Actuator  
▶ EB 5857
- Type 5827 Electric Actuator  
▶ EB 5827-1/-2
- TROVIS 5757-7 Electric Actuator with Process Controller ▶ EB 5757-7
- TROVIS 5724-8 Electric Actuator with Process Controller ▶ EB 5724-8
- TROVIS 5725-8 Electric Actuator with Process Controller ▶ EB 5724-8
- Type 2780 Pneumatic Actuator  
▶ EB 5840

## 5.3.3 Connecting the actuator

Perform the electrical or pneumatic connection of the actuator as described in the associated actuator documentation.

## 5.3.4 Configuring the actuator

The electric actuator versions with positioner as well as electric actuators with process controller can be adapted to the control task.

Configure the actuator as described in the associated actuator documentation.

---

### **i** Note

*For electric control valves with positioner, an initialization needs to be performed after the initial start-up (see associated documentation).*

---

## 5.4 Testing the installed valve

---

### **⚠ DANGER**

***Risk of bursting due to incorrect opening of pressurized equipment or components.***

*Control valves and pipelines are pressure equipment that may burst when handled incorrectly. Flying projectile fragments or the release of process medium under pressure can cause serious injury or even death.*

Before starting any work on pressure-bearing or pressure-retaining parts belonging to the valve assembly:

- Depressurize all plant sections affected and the valve (including the actuator). Release any stored energy.
- Drain the process medium from the plant sections affected as well as from the valve.

### **⚠ DANGER**

**Risk of fatal injury due to electric shock.**

- Do not remove any covers to perform adjustment work on live parts.
- Before performing any work on the device and before opening the device, disconnect the supply voltage and protect it against unintentional reconnection.
- Only use power interruption devices that are protected against unintentional reconnection of the power supply.
- The electric actuators are protected against spray water (IP54). Avoid jets of water.

### **⚠ WARNING**

**Risk of hearing loss or deafness due to loud noise.**

Noise emission (e.g. cavitation or flashing) may occur during operation caused by the process medium and the operating conditions. Additionally, a loud noise may briefly occur through the sudden venting of the pneumatic actuator or pneumatic valve

accessories not fitted with noise-reducing elements. Both can damage hearing.

- Follow the standard operating procedures provided by the plant operator. In the event of a potential risk:
- Wear hearing protection when working near the valve.

### **⚠ WARNING**

**Risk of burn injuries due to hot components and pipeline.**

Valve components and the pipeline may become very hot. Risk of burn injuries.

- Follow the standard operating procedures provided by the plant operator. In the event of a potential risk:
- Allow components and pipelines to cool down.
- Wear protective clothing and safety gloves.

### **⚠ WARNING**

**Type 3226/2780: Crush hazard arising from actuator and plug stem moving.**

- Do not insert hands or finger into the yoke while the air supply is connected to the actuator.
- Before working on the control valve, disconnect and lock the pneumatic air supply as well as the control signal.
- Do not impede the movement of the actuator and plug stem by inserting objects into the yoke.
- Before unblocking the actuator and plug stem after they have become

## Installation

*blocked (e.g. due to seizing up after remaining in the same position for a long time), release any stored energy in the actuator (e.g. spring compression). See associated actuator documentation.*

---

### **WARNING**

#### **Risk of personal injury due to exhaust air being vented from pneumatic devices.**

*While the valve is operating, the Type 2780 Pneumatic Actuator may vent during closed-loop control or when the valve opens or closes.*

→ *Wear eye protection when working in close proximity to the control valve.*

---

### **WARNING**

#### **Risk of personal injury due to preloaded springs in pneumatic actuators.**

*Actuators with preloaded springs are under tension. They can be identified by the long bolts protruding from the bottom of the actuator.*

→ *Before starting any work on the actuator, relieve the compression from the preloaded springs (see associated actuator documentation).*

---

To test the valve functioning before start-up or putting back the valve into operation, perform the following tests:

## 5.4.1 Leak test

The plant operator is responsible for performing the leak test and selecting the test method. The leak test must comply with the requirements of the national and international standards that apply at the site of installation.

---

### **Tip**

*Our after-sales service can support you to plan and perform a leak test for your plant.*

---

1. Slowly apply the test medium to the valve until the test pressure is reached. Avoid sudden surges in pressure since the resulting high velocities may damage the valve.
2. Check the valve for leakage to the atmosphere.
3. Depressurize the pipeline section and valve.
4. Rework any parts that leak and repeat the leak test.

## 5.4.2 Travel motion

The movement of the actuator stem must be linear and smooth.

- Apply the maximum and minimum control signals to check the end positions of the valve while observing the movement of the actuator stem.
- Check the travel reading at the travel indicator scale.



### 5.4.3 Fail-safe position

#### Fail-safe position with pneumatic actuators

- Shut off the signal pressure line.
- Check whether the valve moves to the fail-safe position (see the 'Design and principle of operation' chapter).

#### Fail-safe position for electric actuators and electric actuators with process controller with fail-safe action

- Switch off the supply voltage.
- Check whether the valve moves to the fail-safe position (see the 'Design and principle of operation' chapter).

### 5.4.4 Pressure test

The plant operator is responsible for performing the pressure test.

---

**i Note**

*Our after-sales service can support you to plan and perform a pressure test for your plant.*

---

During the pressure test, make sure the following conditions are met:

- Retract the plug stem to open the valve.
- Observe the maximum permissible pressure for both the valve and plant.



## 6 Start-up

The work described in this chapter is to be performed only by personnel appropriately qualified to carry out such tasks.

### **⚠ WARNING**

#### **Risk of hearing loss or deafness due to loud noise.**

Noise emission (e.g. cavitation or flashing) may occur during operation caused by the process medium and the operating conditions. Additionally, a loud noise may briefly occur through the sudden venting of the pneumatic actuator or pneumatic valve accessories not fitted with noise-reducing elements. Both can damage hearing.

- Follow the standard operating procedures provided by the plant operator. In the event of a potential risk:
- Wear hearing protection when working near the valve.

### **⚠ WARNING**

#### **Risk of burn injuries due to hot components and pipeline.**

Valve components and the pipeline may become very hot. Risk of burn injuries.

- Follow the standard operating procedures provided by the plant operator. In the event of a potential risk:
- Allow components and pipelines to cool down.
- Wear protective clothing and safety gloves.

### **⚠ WARNING**

#### **Type 3226/2780: Crush hazard arising from actuator and plug stem moving.**

- Do not insert hands or finger into the yoke while the air supply is connected to the actuator.
- Before working on the control valve, disconnect and lock the pneumatic air supply as well as the control signal.
- Do not impede the movement of the actuator and plug stem by inserting objects into the yoke.
- Before unblocking the actuator and plug stem after they have become blocked (e.g. due to seizing up after remaining in the same position for a long time), release any stored energy in the actuator (e.g. spring compression). See associated actuator documentation.

### **⚠ WARNING**

#### **Risk of personal injury due to exhaust air being vented from pneumatic devices.**

While the valve is operating, the Type 2780 Pneumatic Actuator may vent during closed-loop control or when the valve opens or closes.

- Wear eye protection when working in close proximity to the control valve.

## Start-up

Before start-up or putting the valve back into service, make sure the following conditions are met:

- The control valve is properly installed in the pipeline (see the 'Installation' chapter).
- The leak and function tests have been completed successfully (see the 'Testing the installed valve' chapter).
- The prevailing conditions in the plant section concerned meet the valve sizing requirements (see section 'Intended use' in the 'Safety instructions and measures' chapter).

### **Start-up/putting the device back into operation**

1. Allow the valve to warm up to reach ambient temperature before start-up when the ambient temperature and process medium temperature differ greatly or the medium properties require such a measure.
2. Slowly open the shut-off valves in the pipeline. Slowly opening these valves prevents a sudden surge in pressure and high flow velocities which may damage the valve.
3. Check the valve to ensure it functions properly.

## 7 Operation

Immediately after completing start-up or placing the valve back into service (see the 'Start-up' chapter), the valve is ready for use.

### **⚠ WARNING**

#### **Risk of hearing loss or deafness due to loud noise.**

Noise emission (e.g. cavitation or flashing) may occur during operation caused by the process medium and the operating conditions. Additionally, a loud noise may briefly occur through the sudden venting of the pneumatic actuator or pneumatic valve accessories not fitted with noise-reducing elements. Both can damage hearing.

- Follow the standard operating procedures provided by the plant operator. In the event of a potential risk:
  - Wear hearing protection when working near the valve.

### **⚠ WARNING**

#### **Risk of burn injuries due to hot components and pipeline.**

Valve components and the pipeline may become very hot. Risk of burn injuries.

- Follow the standard operating procedures provided by the plant operator. In the event of a potential risk:
  - Allow components and pipelines to cool down.
  - Wear protective clothing and safety gloves.

### **⚠ WARNING**

#### **Type 3226/2780: Crush hazard arising from actuator and plug stem moving.**

- Do not insert hands or finger into the yoke while the air supply is connected to the actuator.
- Before working on the control valve, disconnect and lock the pneumatic air supply as well as the control signal.
- Do not impede the movement of the actuator and plug stem by inserting objects into the yoke.
- Before unblocking the actuator and plug stem after they have become blocked (e.g. due to seizing up after remaining in the same position for a long time), release any stored energy in the actuator (e.g. spring compression). See associated actuator documentation.

### **⚠ WARNING**

#### **Risk of personal injury due to exhaust air being vented from pneumatic devices.**

While the valve is operating, the Type 2780 Pneumatic Actuator may vent during closed-loop control or when the valve opens or closes.

- Wear eye protection when working in close proximity to the control valve.



## 8 Malfunctions

**Read hazard statements, warnings and caution notes in the 'Safety instructions and measures' chapter.**

Depending on the operating conditions, check the control valve at certain intervals to prevent possible failure before it can occur. Plant operators are responsible for drawing up an inspection and test plan.



### Tip

*Our after-sales service can support you in drawing up an inspection and test plan for your plant.*

### 8.1 Troubleshooting

Malfunction	Possible reasons	Recommended action
Actuator and plug stem does not move on demand.	Actuator is blocked.	Check attachment. Remove the blockage. Type 3226/2780: <b>WARNING!</b> A blocked actuator or plug stem (e.g. due to seizing up after remaining in the same position for a long time) can suddenly start to move uncontrollably. Injury to hands or fingers is possible if they are inserted into the actuator or valve. Before trying to unblock the actuator or plug stem, disconnect and lock the pneumatic air supply as well as the control signal. Before unblocking the actuator, release any stored energy in the actuator (e.g. spring compression). See associated actuator documentation.
	Pneumatic actuators: diaphragm in the actuator defective	See associated actuator documentation.
	Electric actuators: no or incorrect supply voltage connected	Check the supply voltage and connections.
	Pneumatic actuators: signal pressure too low	Check the signal pressure. Check the signal pressure line for leakage.

## Malfunctions

Malfunction	Possible reasons	Recommended action
Actuator and plug stem does not stroke through the full range.	Pneumatic actuators: signal pressure too low	Check the signal pressure. Check the signal pressure line for leakage.
	Electric actuators: no or incorrect supply voltage connected	Check the supply voltage and connections.
Increased flow through closed valve (seat leakage)	Dirt or other foreign particles deposited between the seat and plug.	Shut off the section of the pipeline and flush the valve.
	Valve trim is worn out.	Contact our after-sales service.
The valve leaks to the atmosphere (fugitive emissions).	Plug stem seal defective	Contact our after-sales service.
	Flanged joint loose or gasket worn out	Check the flanged joint.

---

### **i** Note

Contact our after-sales service for malfunctions not listed in the table.

---

## 8.2 Emergency action

The valve, on which the actuator with fail-safe action is mounted, is moved to its fail-safe position upon failure of the supply voltage or signal pressure (see the 'Design and principle of operation' chapter).

Plant operators are responsible for emergency action to be taken in the plant.

In the event of a valve malfunction:

1. Close the shut-off valves upstream and downstream of the control valve to stop the process medium from flowing through the valve.
2. Perform troubleshooting (see Chapter 8.1).
3. Rectify those malfunctions that can be remedied following the information given in this document. Contact our after-sales service in all other cases.

### **Putting the device back into operation after a malfunction**

See the 'Start-up' chapter.



## 9 Servicing

---

### **i Note**

*The control valve was checked by SAMSON before delivery.*

- The product warranty becomes void if service or repair work not described in these instructions is performed without prior agreement by SAMSON's After-sales Service.*
  - Only use original spare parts by SAMSON, which comply with the original specifications.*
- 

### **Ordering spare parts and operating supplies**

Contact your nearest SAMSON subsidiary or SAMSON's After-sales Service for information on spare parts, lubricants and tools.



## 10 Decommissioning

The work described in this chapter is to be performed only by personnel appropriately qualified to carry out such tasks.

### **⚠ DANGER**

**Risk of bursting due to incorrect opening of pressurized equipment or components.**

Control valves and pipelines are pressure equipment that may burst when handled incorrectly. Flying projectile fragments or the release of process medium under pressure can cause serious injury or even death.

Before starting any work on pressure-bearing or pressure-retaining parts belonging to the valve assembly:

- Depressurize all plant sections affected and the valve (including the actuator). Release any stored energy.
- Drain the process medium from the plant sections affected as well as from the valve.

### **⚠ DANGER**

**Risk of fatal injury due to electric shock.**

- Do not remove any covers to perform adjustment work on live parts.
- Before performing any work on the device and before opening the device, disconnect the supply voltage and protect it against unintentional reconnection.

- Only use power interruption devices that are protected against unintentional reconnection of the power supply.
- The electric actuators are protected against spray water (IP54). Avoid jets of water.

### **⚠ WARNING**

**Risk of hearing loss or deafness due to loud noise.**

Noise emission (e.g. cavitation or flashing) may occur during operation caused by the process medium and the operating conditions. Additionally, a loud noise may briefly occur through the sudden venting of the pneumatic actuator or pneumatic valve accessories not fitted with noise-reducing elements. Both can damage hearing.

- Follow the standard operating procedures provided by the plant operator. In the event of a potential risk:
  - Wear hearing protection when working near the valve.

### **⚠ WARNING**

**Risk of burn injuries due to hot components and pipeline.**

Valve components and the pipeline may become very hot. Risk of burn injuries.

- Follow the standard operating procedures provided by the plant operator. In the event of a potential risk:
  - Allow components and pipelines to cool down.

## Decommissioning

- Wear protective clothing and safety gloves.

---

### **⚠ WARNING**

#### **Type 3226/2780: Crush hazard arising from actuator and plug stem moving.**

- Do not insert hands or finger into the yoke while the air supply is connected to the actuator.
- Before working on the control valve, disconnect and lock the pneumatic air supply as well as the control signal.
- Do not impede the movement of the actuator and plug stem by inserting objects into the yoke.
- Before unblocking the actuator and plug stem after they have become blocked (e.g. due to seizing up after remaining in the same position for a long time), release any stored energy in the actuator (e.g. spring compression). See associated actuator documentation.

---

### **⚠ WARNING**

#### **Risk of personal injury due to exhaust air being vented from pneumatic devices.**

While the valve is operating, the Type 2780 Pneumatic Actuator may vent during closed-loop control or when the valve opens or closes.

- Wear eye protection when working in close proximity to the control valve.

---

### **⚠ WARNING**

#### **Risk of personal injury due to residual process medium in the valve.**

While working on the valve, residual process medium can escape and, depending on its properties, may lead to personal injury, e.g. burns.

- Follow the standard operating procedures provided by the plant operator. In the event of a potential risk:
  - Wear protective clothing, safety gloves, respiratory protection and eye protection.

---

To put the control valve out of operation before removing it, proceed as follows:

1. Close the shut-off valves upstream and downstream of the control valve to stop the process medium from flowing through the valve.
2. Completely drain the pipelines and valve.
3. Disconnect and lock the pneumatic air supply or supply voltage to depressurize or de-energize the actuator.
4. Release any stored energy.
5. If necessary, allow the pipeline and valve components to cool down.

## 11 Removal

The work described in this chapter is to be performed only by personnel appropriately qualified to carry out such tasks.

### **⚠ WARNING**

#### **Risk of burn injuries due to hot components and pipeline.**

Valve components and the pipeline may become very hot. Risk of burn injuries.

- Follow the standard operating procedures provided by the plant operator. In the event of a potential risk:
  - Allow components and pipelines to cool down.
  - Wear protective clothing and safety gloves.

### **⚠ WARNING**

#### **Type 3226/2780: Crush hazard arising from actuator and plug stem moving.**

- Do not insert hands or finger into the yoke while the air supply is connected to the actuator.
- Before working on the control valve, disconnect and lock the pneumatic air supply as well as the control signal.
- Do not impede the movement of the actuator and plug stem by inserting objects into the yoke.
- Before unblocking the actuator and plug stem after they have become blocked (e.g. due to seizing up after remaining in the same position for a long time), release any stored energy in the actuator (e.g. spring compression).

See associated actuator documentation.

### **⚠ WARNING**

#### **Risk of personal injury due to preloaded springs in pneumatic actuators.**

Actuators with preloaded springs are under tension. They can be identified by the long bolts protruding from the bottom of the actuator.

- Before starting any work on the actuator, relieve the compression from the preloaded springs (see associated actuator documentation).

### **⚠ WARNING**

#### **Risk of personal injury due to residual process medium in the valve.**

While working on the valve, residual process medium can escape and, depending on its properties, may lead to personal injury, e.g. burns.

- Follow the standard operating procedures provided by the plant operator. In the event of a potential risk:
  - Wear protective clothing, safety gloves, respiratory protection and eye protection.

Before removing, make sure that the following conditions are met:

- The control valve is put out of operation (see the 'Decommissioning' chapter).

## Removal

### **11.1 Removing the valve from the pipeline**

1. Undo the joint between the valve and pipeline.
2. Remove the valve from the pipeline.

### **11.2 Removing the actuator**

See associated actuator documentation.

## 12 Repairs

If the control valve does not function properly according to how it was originally sized or does not function at all, it is defective and must be repaired or exchanged.

### ! NOTICE

***Risk of valve damage due to incorrect service or repair work.***

- ➔ *Do not perform any repair work on your own.*
- ➔ *Contact SAMSON's After-sales Service for service and repair work.*

### 12.1 Returning devices to SAMSON

Defective devices can be returned to SAMSON for repair.

Proceed as follows to return devices:

1. Exceptions apply concerning some special device models ► [www.samsongroup.com](http://www.samsongroup.com) > Service > After-sales Service > Returning goods.
2. Send an e-mail ► [returns-de@samsongroup.com](mailto:returns-de@samsongroup.com) to register the return shipment including the following information:
  - Type
  - Article number
  - Configuration ID
  - Original order

- Completed Declaration on Contamination, which can be downloaded from our website at ► [www.samsongroup.com](http://www.samsongroup.com) > Service > After-sales Service > Returning goods.

**After checking your registration, we will send you a return merchandise authorization (RMA).**

3. Attach the RMA (together with the Declaration on Decontamination) to the outside of your shipment so that the documents are clearly visible.
4. Send the shipment to the address given on the RMA.

### i Note

*Further information on returned devices and how they are handled can be found at ► [www.samsongroup.com](http://www.samsongroup.com) > Service > After-sales Service.*





## 13 Disposal

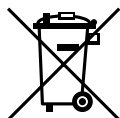

SAMSON is a producer registered in Europe. ► <https://www.samsongroup.com> > About SAMSON > Environment, Social & Governance > Material Compliance > Waste electrical and electronic equipment (WEEE) WEEE reg. no.: DE 62194439

Information on substances listed as substances of very high concern (SVHC) on the candidate list of the REACH regulation can be found in the document "Additional Information on Your Inquiry/Order", which is added to the order documents, if applicable. This document includes the SCIP number assigned to the devices concerned. This number can be entered into the database on the European Chemicals Agency (ECHA) website (► <https://www.echa.europa.eu/scip-database>) to find out more information on the SVHC contained in the device.

### **i** Note

*SAMSON can provide you with a recycling passport according to PAS 1049 on request. Simply e-mail us at [aftersalesservice@samsongroup.com](mailto:aftersalesservice@samsongroup.com) giving details of your company address.*

### **💡** Tip

*On request, SAMSON can appoint a service provider to dismantle and recycle the product as part of a distributor take-back scheme.*

- ➔ Observe local, national and international refuse regulations.
- ➔ Do not dispose of components, lubricants and hazardous substances together with your household waste.



## 14 Certificates

The declaration is included on the next pages:

- Declaration of conformity in compliance with Pressure Equipment Directive 2014/68/EU on pages 14-2 to 14-4

The certificates shown were up to date at the time of publishing. The latest certificates can be found on our website:

▶ [www.samsongroup.com](http://www.samsongroup.com) > *Products* > *Valves* > 3226

Other optional certificates are available on request.

# EU DECLARATION OF CONFORMITY TRANSLATION



## Module A

For the following products, SAMSON hereby declares under its sole responsibility:

Devices	Series	Type	Version				
Self-operated Regulators	43	2432	DIN EN, body, CC499K and EN-GJS-400-18-LT, DN 50, PN 25, fluids G2, L2, L1 <sup>1)</sup>				
	43	2436	DIN EN, body, CC499K and EN-GJS-400-18-LT, DN 50, PN 25, fluids G2, L2, L1 <sup>1)</sup>				
	43	2437	DIN EN, body, CC499K and EN-GJS-400-18-LT, DN 50, PN 25, fluids G2, L2, L1 <sup>1)</sup>				
	---	2111	DIN EN, body, EN-GJS-400-18-LT, DN 50, PN 25, fluids G2, L2, L1 <sup>1)</sup> DIN EN, body, 1.0619 and 1.4408, DN 40-50, PN 40, fluids G2, L2, L1 <sup>1)</sup> ANSI, body, A216 WCC and A351 CF8M, NPS 1½-2, Class 300, fluids G2, L2, L1 <sup>1)</sup>				
Three-way valve	---	2119	DIN EN, body, EN-GJL-250 and 1.0619, DN 65-125, PN 16, fluids G2, L2, L1 <sup>1)</sup> DIN EN, body, 1.0619, DN 50-80, PN 25, fluids G2, L2, L1 <sup>1)</sup> DIN EN, body, 1.0619 and 1.4408, DN 40-50, PN 40, fluids G2, L2, L1 <sup>1)</sup> ANSI, body, A216 WCC and A351 CF8M, NPS 2½-4, Class 150, fluids G2, L2, L1 <sup>1)</sup> ANSI, body, A216 WCC and A351 CF8M, NPS 1½, Class 300, fluids G2, L2, L1 <sup>1)</sup>				
			Control valve	---	3222	DIN EN, body, EN-GJS-400-18-LT, DN 50, PN 25, fluids G2, L2, L1 <sup>1)</sup> DIN EN, body, CC499K, DN 32-40, PN 25, all fluids	
			Three-way valve	---	3226	DIN EN, body, CC499K, DN 50, PN 25, fluids G2, L2 <sup>2)</sup>	
			Three-way valve	---	3260	DIN EN, body, EN-GJL-250, DN 65-200, PN 16, fluids G2, L2 <sup>2)</sup> DIN EN, body, EN-GJS-400-18-LT, DN 50-80, PN 25, fluids G2, L2, L1 <sup>1)</sup>	
Globe valve Three-way valve	V2001	3531 3535	DIN EN, body, 1.0619 and 1.4408, DN 32-40, PN 25, all fluids ANSI, body, A216 WCC and A351 CF8M, NPS 1½-2, Class 150, all fluids				
			Control valve	---	3214	DIN EN, body, EN-GJL-250, DN 65-125, PN 16, fluids G2, L2, L1 <sup>1)</sup> DIN EN, body, EN-GJS-400-18-LT, DN 50-80, PN 25, fluids G2, L2, L1 <sup>1)</sup> ANSI, body, A126 B, NPS 3-4, Class 125, fluids G2, L2, L1 <sup>1)</sup> ANSI, body, A216 WCC and A351 CF8M, NPS 1½-2, Class 150, all fluids	
Self-operated Regulators	42	2423	DIN EN, body, EN-GJL-250 and EN-GJS-400-18-LT, DN 65-125, PN 16, fluids G2, L2, L1 <sup>1)</sup> DIN EN, body, EN-GJS-418-LT, DN 50-80, PN 25, fluids G2, L2, L1 <sup>1)</sup> DIN EN, body, 1.0619 and 1.4408, DN 32-50, PN 16, all fluids DIN EN, body, 1.0619 and 1.4408, DN 32-40, PN 25, all fluids ANSI, body, A126 B, NPS 3-4, Class 125, fluids G2, L2, L1 <sup>1)</sup>				
			42	2422	ANSI, body, A216 WCC and A351 CF8M, NPS 1½-2, Class 150, all fluids DIN EN, body, EN-GJL-250 and EN-GJS-400-18-LT, DN 65-125, PN 16, fluids G2, L2, L1 <sup>1)</sup> DIN EN, body, EN-GJS-400-18-LT, DN 50-80, PN 25, fluids G2, L2, L1 <sup>1)</sup> DIN EN, body, 1.0619, 1.4408 and 1.6220+QT, DN 32-50, PN 16, all fluids ANSI, body, A126 B, NPS 3-4, Class 125, fluids G2, L2, L1 <sup>1)</sup> ANSI, body, A216 WCC, A351 CF8M and A352 LCC, NPS 1½-2, Class 150, all fluids		
					Strainers	1N/1NI	2601
	Strainers	2N/2NI			2602	DIN EN, body, EN-GJL-250, DN 200-250, PN 10, fluids G2, L2, L1 <sup>1)</sup> DIN EN, body, EN-GJL-250, DN 65-125, PN 16, fluids G2, L2, L1 <sup>1)</sup> DIN EN, body, EN-GJS-400-18-LT, DN 100-125, PN 16, fluids G2, L2, L1 <sup>1)</sup> DIN EN, body, EN-GJS-400-18-LT, DN 50-80, PN 25, fluids G2, L2, L1 <sup>1)</sup> DIN EN, body, 1.4408, DN 32-50, PN 16, all fluids	
			---	---		2373/2375	ANSI, body, A995 4A and A995 5A, NPS 1½-2, Class 150, all fluids
			Self-operated Regulators	44		2440 (44-0B) 2441 (44-1B) 2446 (44-6B)	DIN EN, body, EN-GJS-400-18-LT, DN 50, PN 25, fluids G2, L2, L1 <sup>1)</sup>
2442 (44-2) 2443 (44-3) 2444 (44-4) 2447 (44-7) 2449 (44-9)						DIN EN, body, EN-GJS-400-18-LT and CC499K, DN 50, PN 25, fluids G2, L2, L1 <sup>1)</sup>	

Revision 01

Classification: Public · SAMSON AKTIENGESELLSCHAFT · Weismuellerstrasse 3 · 60314 Frankfurt am Main, Germany

Page 1 of 3

# EU DECLARATION OF CONFORMITY TRANSLATION



Devices	Series	Type	Version
Self-operated Regulators	45	2451 (45-1)	DIN EN, body, EN-GJS-400-18-LT and CC499K, DN 50, PN 25, fluids G2, L2, L1 <sup>1)</sup>
		2452 (45-2)	
		2453 (45-3)	
		2454 (45-4)	
		2459 (45-9)	
	46	2465 (46-5)	DIN EN, body, EN-GJS-400-18-LT and CC499K, DN 50, PN 25, fluids G2, L2, L1 <sup>1)</sup>
		2466 (46-6)	
		2467 (46-7)	
		2469 (46-9)	
	47	2471 (47-1)	DIN EN, body, EN-GJS-400-18-LT and CC499K, DN 50, PN 25, fluids G2, L2, L1 <sup>1)</sup>
		2474 (47-4)	
		2475 (47-5)	
		2479 (47-9)	
	48	2488	DIN EN, body, EN-GJS-400-18-LT and CC499K, DN 50, PN 25, fluids G2, L2, L1 <sup>1)</sup>
		2489	
	40	2405	DIN EN, body, EN-GJS-400-18-LT, DN 50, PN 25, fluids G2, L2, L1 <sup>1)</sup>
			ANSI, body, A216 WCC and A351 CF8M, NPS 1½-2, Class 150, all fluids
			DIN EN, body, EN-GJL-250, DN 65-125, PN 16, fluids G2, L2, L1 <sup>1)</sup>
		2406	DIN EN, body, EN-GJS-400-18-LT, DN 50, PN 25, fluids G2, L2, L1 <sup>1)</sup>
			ANSI, body, A126 B, NPS 3-4, Class 125, fluids G2, L2, L1 <sup>1)</sup>
			ANSI, body, A216 WCC and A351 CF8M, NPS 1½-2, Class 150, all fluids
	41	2412 2417	DIN EN, body, EN-GJL-250, DN 65-100, PN 16, fluids G2, L2, L1 <sup>1)</sup>
			DIN EN, body, EN-GJS-400-18-LT, DN 50-80, PN 25, fluids G2, L2, L1 <sup>1)</sup>
			ANSI body, A126 B, NPS 3-4, Class 125, fluids G2, L2, L1 <sup>1)</sup>
			ANSI, body, A216 WCC and A351 CF8M, NPS 1½-2, Class 150, all fluids
	42	2421 RS	DIN EN, body, 1.0619, 1.4408, 1.4571 and 1.4401/1.4404, DN 32-50, PN 16, all fluids
			DIN EN, body, 1.0619, 1.4408, 1.4571 and 1.4401/1.4404, DN 32-40, PN 25, all fluids
			ANSI, body, A216 WCC, A351 CF8M and A182 F316/A182 F316L, NPS 1½-2, Class 150, all fluids
	---	2331	DIN EN, body, EN-GJL-250, DN 65-200, PN 16, fluids G2, L2 <sup>2)</sup>
			DIN EN, body, EN-GJS-400-18-LT, DN 65-150, PN 16, fluids G2, L2 <sup>2)</sup>
			DIN EN, body, EN-GJS-400-18-LT, DN 65-125, PN 25, fluids G2, L2 <sup>2)</sup>
			DIN EN, body 1.0619, DN 65-200, PN 16, fluids G2, L2 <sup>2)</sup>
	---	2337	DIN EN, body 1.0619, DN 65-100, PN 40, fluids G2, L2 <sup>2)</sup>
DIN EN, body 1.0619, DN 250, PN 25, fluids L1 <sup>1)</sup>			
---	2333 2335	DIN EN, body 1.0619, DN 250, PN 40, fluids L1 <sup>1)</sup>	
		DIN EN, body, EN-GJL-250, DN 65-125, PN 16, fluids G2, L2, L1 <sup>1)</sup>	
---	2334	DIN EN, body, EN-GJS-400-18-LT, DN 65-80, PN 25, fluids G2, L2, L1 <sup>1)</sup>	
		ANSI body, A126 B, NPS 3-4, Class 125, fluids G2, L2, L1 <sup>1)</sup>	
---	2404-1	DIN EN, body, EN-GJL-250, DN 65-125, PN 16, fluids G2, L2, L1 <sup>1)</sup>	
		DIN EN, body, EN-GJS-400-18-LT, DN 65-125, PN 16, fluids G2, L2, L1 <sup>1)</sup>	
		DIN EN, body, EN-GJS-400-18-LT, DN 65-80, PN 25, fluids G2, L2, L1 <sup>1)</sup>	
---	2404-2	ANSI, body, A126 B, NPS 3-4, Class 125, fluids G2, L2, L1 <sup>1)</sup>	
		DIN EN, body, EN-GJL-250, DN 65-125, PN16, fluids G2, L2, L1 <sup>1)</sup>	
---	2404-1	ANSI body, A216 WCC and A351 CF8M, NPS 1½-2, Class 150, all fluids	
		ANSI, body, A216 WCC and A351 CF8M, NPS 1½-2, Class 150, all fluids	
---	2404-2	DIN EN, body, EN-GJL-250, DN 65-125, PN 16, fluids G2, L2, L1 <sup>1)</sup>	
		ANSI, body, A126 B, NPS 3-4, Class 125, fluids G2, L2, L1 <sup>1)</sup>	

<sup>1)</sup> Gases according to Article 4(1)(c.i), second indent  
Liquids according to Article 4(1)(c.ii)

<sup>2)</sup> Gases according to Article 4(1)(c.i), second indent  
Liquids according to Article 4(1)(c.ii), second indent

# EU DECLARATION OF CONFORMITY

## TRANSLATION



That the products mentioned above comply with the requirements of the following standards:

Directive of the European Parliament and of the Council on the harmonization of the laws of the Member States relating to the making available on the market of pressure equipment	2014/68/EU	of 15. May 2014
Applied conformity assessment procedure for fluids according to Article 4(1)	Module A	

**Technical standards applied: DIN EN 12516-2, DIN EN 12516-3, ASME B16.34**

**Manufacturer: SAMSON AG, Weismüllerstraße 3, 60314 Frankfurt am Main, Germany**

Frankfurt am Main, 05. June 2024

ppc. Norbert Tollas  
Senior Vice President  
Global Operations

i.V. Peter Scheermesser  
Director  
Product Maintenance & Engineered Products

Revision 01

Classification: Public · SAMSON AKTIENGESELLSCHAFT · Weismuellerstrasse 3 · 60314 Frankfurt am Main, Germany

Page 3 of 3

## 15 Appendix

### 15.1 After-sales service

Contact our after-sales service for support concerning service or repair work or when malfunctions or defects arise.

#### E-mail

You can reach our after-sales service at [aftersalesservice@samsongroup.com](mailto:aftersalesservice@samsongroup.com).

#### Addresses of SAMSON AG and its subsidiaries

The addresses of SAMSON AG, its subsidiaries, representatives and service facilities worldwide can be found on our website ([www.samsongroup.com](http://www.samsongroup.com)) or in all SAMSON product catalogs.

#### Required specifications

Please submit the following details:

- Order number and position number in the order
- Type, model number, nominal size and valve version
- Pressure and temperature of the process medium
- Flow rate in m<sup>3</sup>/h
- Bench range (e.g. 0.2 to 1 bar) or input signal of the actuator (e.g. 0 to 20 mA or 0 to 10 V)
- Is a strainer installed?
- Installation drawing











**EB 5863 EN**



SAMSON AKTIENGESELLSCHAFT  
Weismüllerstraße 3 · 60314 Frankfurt am Main, Germany  
Phone: +49 69 4009-0 · Fax: +49 69 4009-1507  
samson@samsongroup.com · www.samsongroup.com